

BUILD FEATURES

- » Powder Coated, Tubular Marine Grade Aluminum with 316L S/S Hardware
- » Personalized Logo/Boat Name
- » Water Connection System
- » King StarBoard Cutting Surface
- » Accessory Tray: S/S Cup Holder, Knife Sharpener, Wash Down Hose & Spray Nozzle

CUSTOM UPGRADES

- » Umbrella Holder
- » Duplex 120V, Power Outlet
- » Multifunctional Shelves & Cabinets
- » Convenience Sink

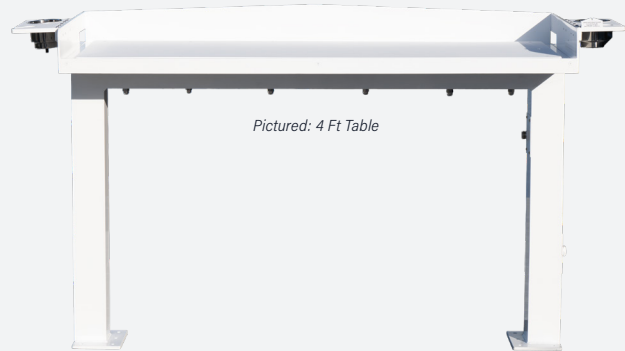

DOCK MOUNT

- » Concrete or Wood | Composite Decking with a Square or C-Mount. Cantilever Available.
- » Additional Support Needed on Some Docks.

INSTALLATION DETAILS

- » Concrete Sea Wall: 3/8" S/S Red Head Type Sleeve Anchors with Nylon Washer, Lock Washer & S/S Acorn Nut
- » Wood | Composite Deck: Lag Bolted & Secured to Deck Cross Member with Marine Grade Aluminum Angle & S/S Hardware

DECK SPACE FOR A 7' STATION: 87" FOR A SQUARE MOUNT, 83" FOR A C-MOUNT

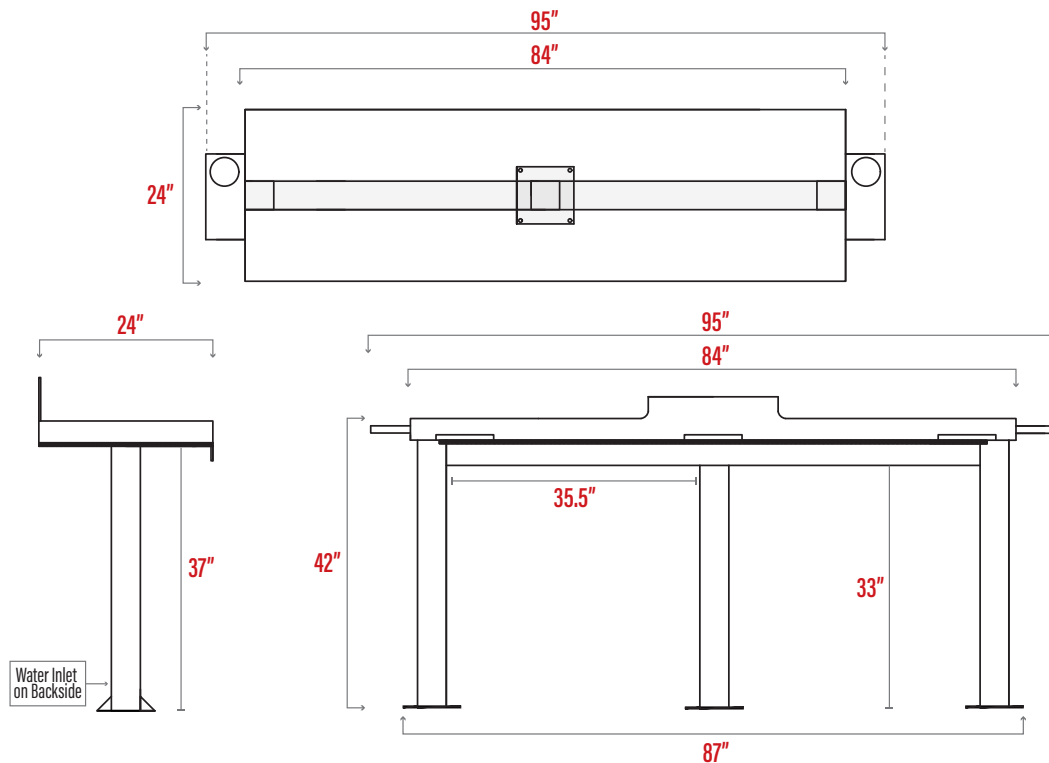

OVERALL DIMENSIONS: 24" X 95" X 42"

Base dimension measures a square mount. Deduct 4" when using a C-mount.

