

**BUILD FEATURES**

- » Powder Coated, Tubular Marine Grade Aluminum with 316L S/S Hardware
- » Personalized Logo/Boat Name
- » Water Connection System
- » King StarBoard Cutting Surface
- » Accessory Tray: S/S Cup Holder, Knife Sharpener, Wash Down Hose & Spray Nozzle
- » Durable Protective Shadecloth Awning

**CUSTOM UPGRADES**

- » LED Light + Switch/Outlet Combo
- » Duplex 120V Power Outlet
- » Multifunctional Shelves & Cabinets
- » Convenience Sink
- » Fish Hanger
- » Weatherproof Fan



*Pictured: 7 Ft Table + Awning*

**4' STATION MUST HAVE AT LEAST 74" OF DECK SPACE TO INSTALL**

**DOCK MOUNT**

- » Concrete or Wood | Composite Decking with a Flat or C-Mount. Cantilever Available.
- » Additional Support Needed on Some Docks.

**INSTALLATION DETAILS**

- » Concrete Sea Wall: 3/8" S/S Red Head Type Sleeve Anchors with Nylon Washer, Lock Washer & S/S Acorn Nut
- » Wood | Composite Deck: Lag Bolted & Secured to Deck Cross Member with Marine Grade Aluminum Angle & S/S Hardware

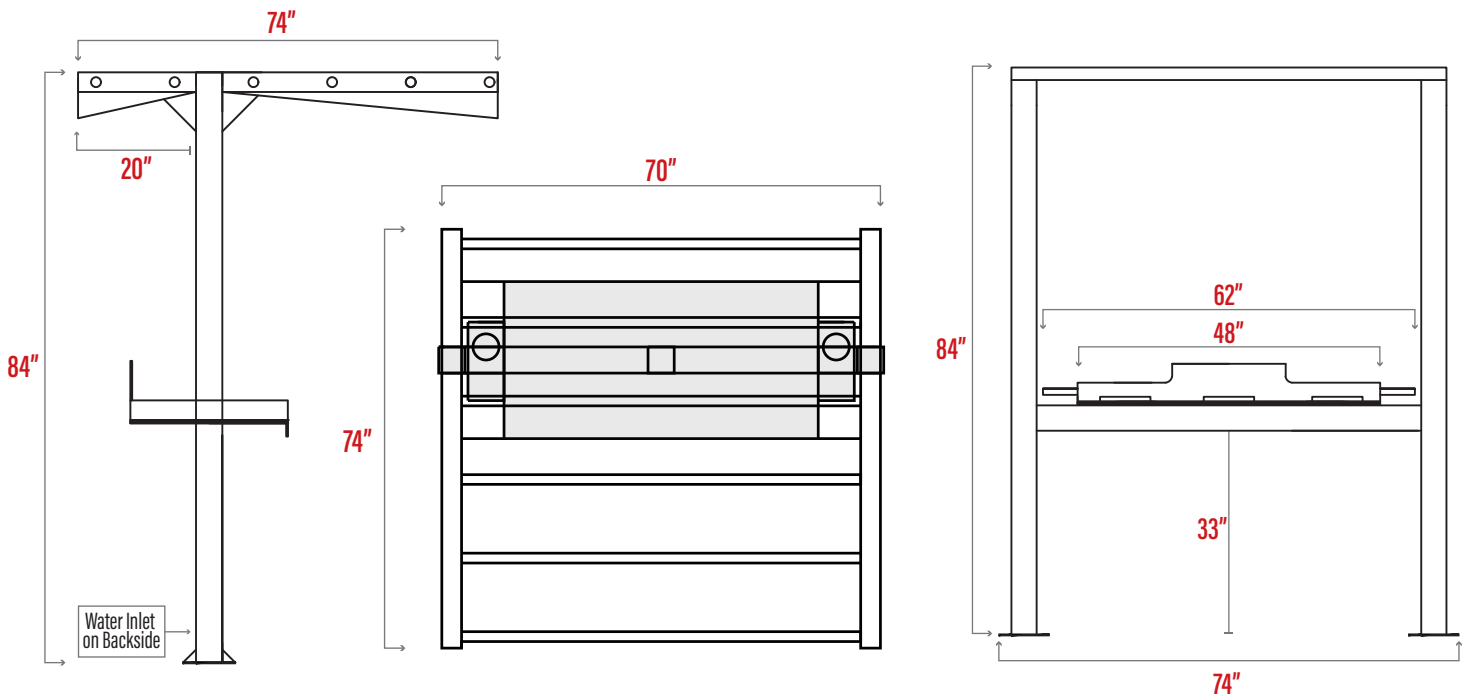

**OVERALL DIMENSIONS: 74" X 74" X 84"**

Base dimension measures a C-mount. Deduct 4" when using a flat mount.

