

### FEATURES & UPGRADES

- » Tubular Marine Grade Aluminum, 316L S/S Hardware & Powder Coated Finish
- » Custom Logo/Boat Name
- » Water Connection System
- » King StarBoard Cutting Surface
- » Accessory Tray: S/S Cup Holder, Knife Sharpener, Wash Down Hose & Spray Nozzle
- » Duplex 120V, Convenience Outlet
- » Multifunctional Shelves & Cabinets
- » Convenience Sink
- » Umbrella Holder

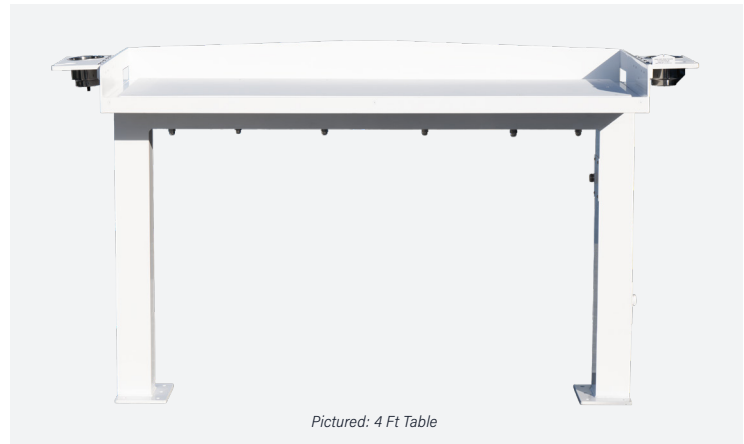

### DOCK INSTALLATION

- » Concrete Sea Wall: 3/8" S/S Red Head Type Sleeve Anchors with Nylon Washer, Lock Washer & S/S Acorn Nut
- » Wood | Composite Deck: Lag Bolted & Secured to Deck Cross Member with Marine Grade Aluminum Angle & S/S Hardware

### DOCK MOUNT

- » Standard Base: Mounts to Top Side of Dock Structure
- » Cantilever: Mounts to Edge of Dock Structure with Overhang Attachment

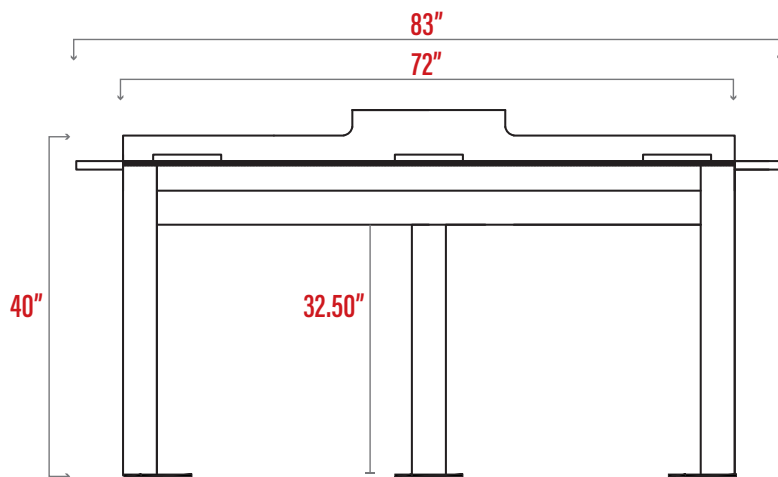
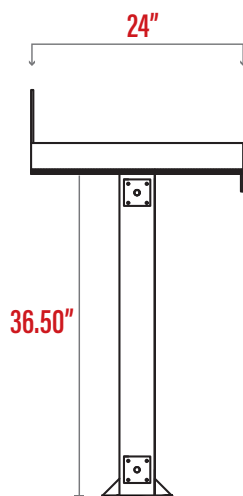
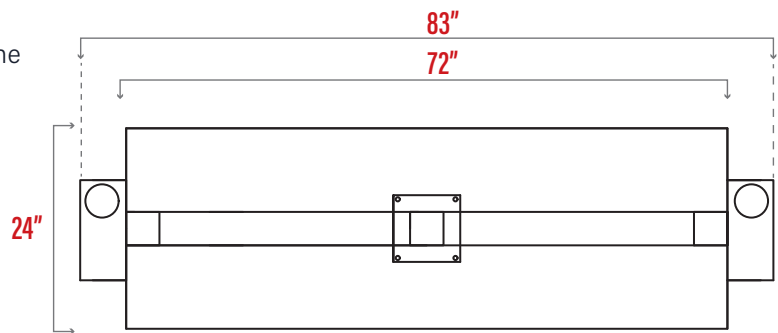

**OVERALL DIMENSIONS: 24" X 83" X 40"**

