

FEATURES

- » Customize with Logo/Boat Name
- » Sunbrella Mesh Awning
- » Long-lasting Powder Coating
- » King StarBoard Cutting Surface
- » Tubular Marine Grade Aluminum
- » 316L S/S Hardware
- » Base Mounted Water Connections
- » Concealed Water Line
- » Wind Load Rated to 150 MPH
- » Stainless Steel Cup Holder
- » Knife Sharpener
- » Wash Down Hose
- » Spray Nozzle

UPGRADES

- » Weatherproof LED Light
- » Duplex 120V, Convenience Outlet
- » Multifunctional Shelves & Cabinets
- » Convenience Sink
- » Custom Features Available

DOCK MOUNT

- » Standard Base: Mounts to Top Side of Dock Structure
- » Cantilever: Mounts to Edge of Dock Structure with Overhang Attachment



DOCK INSTALLATION

- » Concrete Sea Wall: 3/8" S/S Red Head Type Sleeve Anchors with Nylon Washer, Lock Washer & S/S Acorn Nut
- » Wood | Composite Deck: Lag Bolted & Secured to Deck Cross Member with Marine Grade Aluminum Angle & S/S Hardware

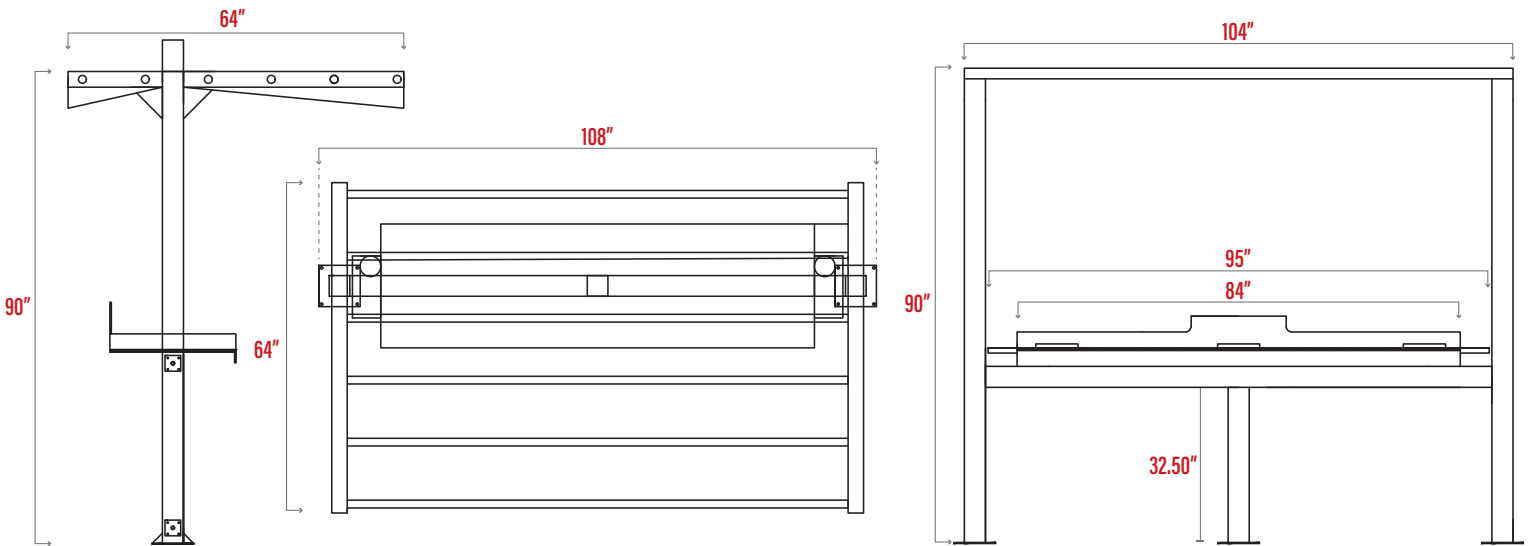

OVERALL DIMENSIONS: 64" X 108" X 90"

